



3D Studio

Protest

Prosthetics

Erik Scollon

Associate Professor, First Year CORE Studio Program
California College of the Arts, San Francisco, CA

escollon@cca.edu & Instagram: @erikscollon

A workshop scene where several people are working on cardboard crafts. In the background, a woman in a black top is focused on her work. To her right, another person is working on a large, multi-faceted cardboard structure. The tables are covered with green cutting mats and various tools like utility knives and rulers. The atmosphere is busy and creative.

**Craft and Measuring
are best friends.**

Size

A measurement of how large or how small something is, often measured in centimeters or inches. Being able to identify the size of something accurately helps artists and designers communicate more clearly.

In addition to measurements of length (height, width, depth) other measurements of size might include weight (pounds or ounces) duration (seconds, minutes) or volume (gallons or cubic meters). Even our digital files are measured for size (bytes).

Dimensions.Guide

Saarinen Tulip Armless Chair

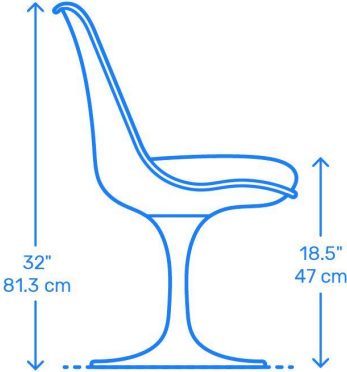

Side



Front

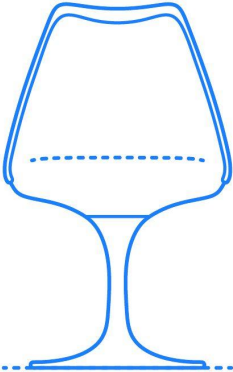

Back

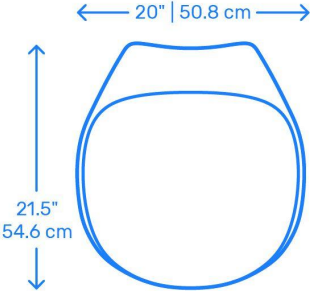

Plan

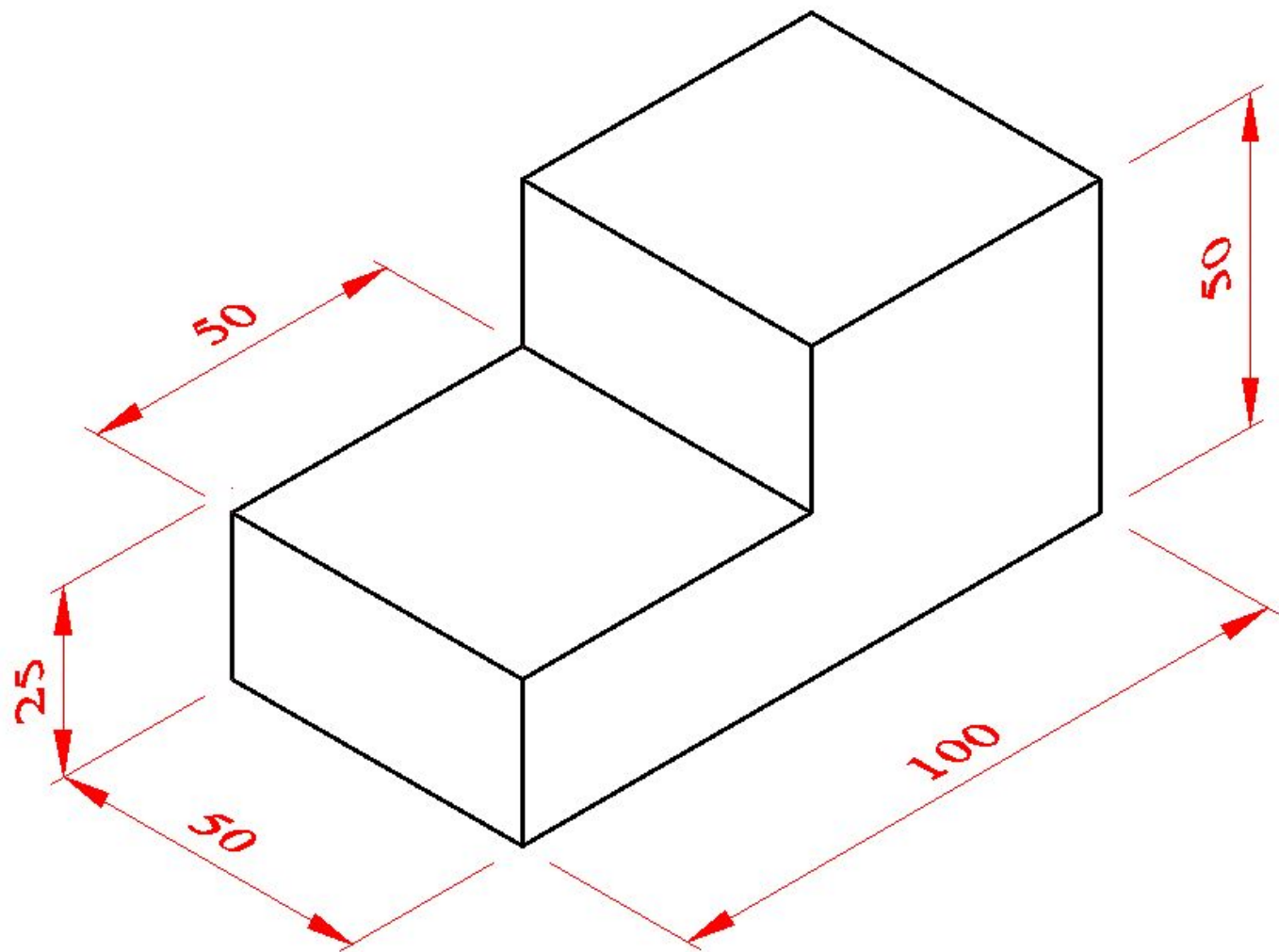

Proportion

Proportion describes relationships of one part to the whole, and of one part to another within an artwork.

Proportion might be thought of as an accurate understanding of size relationships within an artwork. For example in drawing, the appropriate balance between the size of body and the size of the head is a proportional relationship.

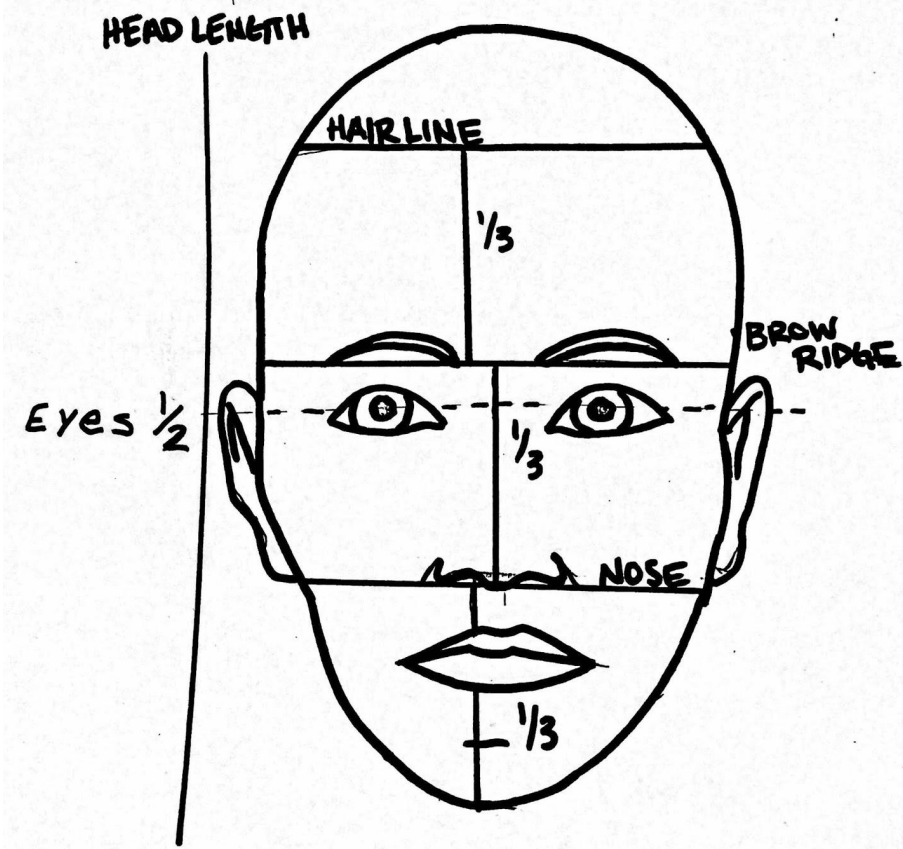

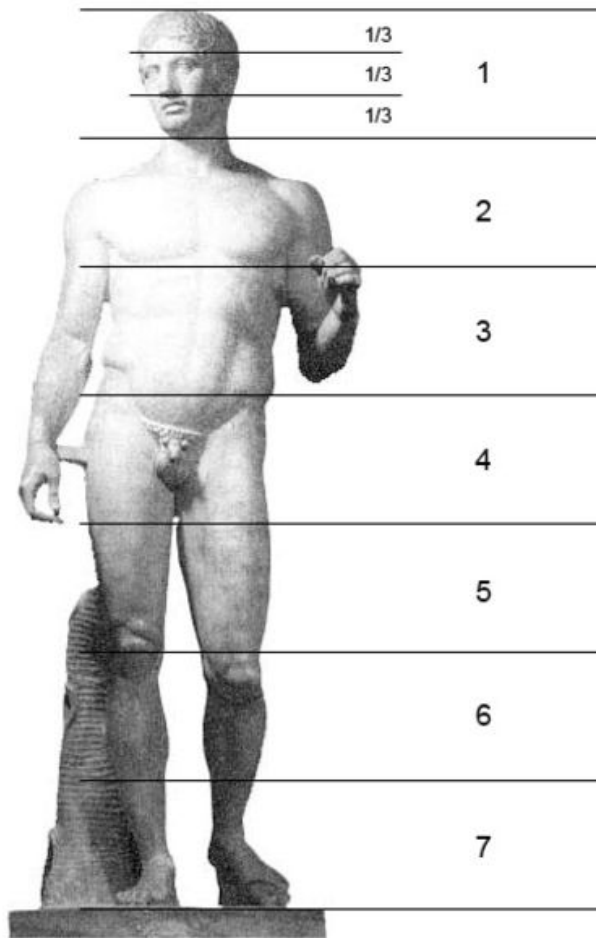



Scale

Scale is the relative size of something when compared to something else.

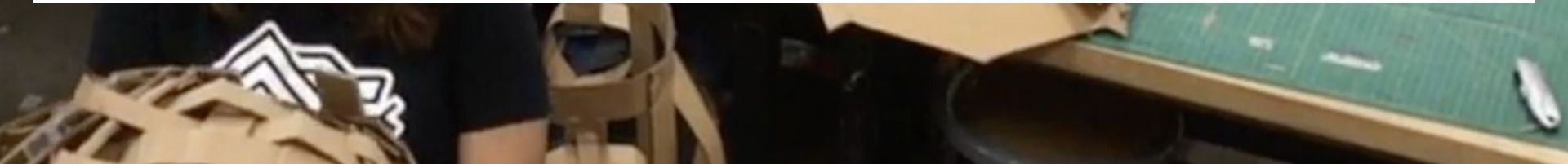









Find your ratio:

Height in real life
Divided by
Height on paper

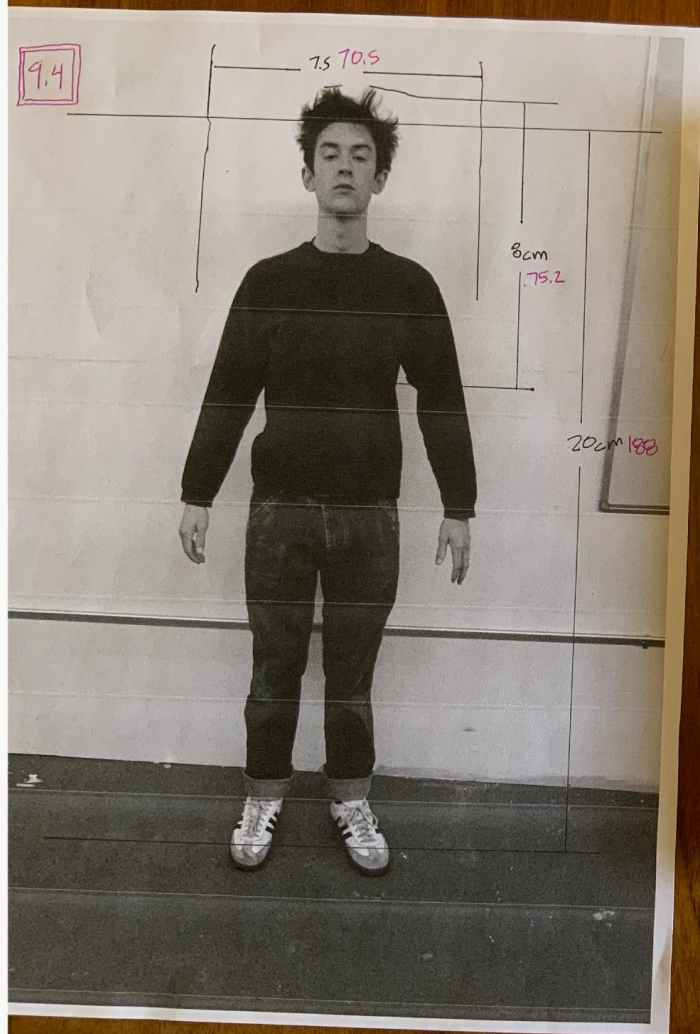

Height in real life

Height on paper

RATIO

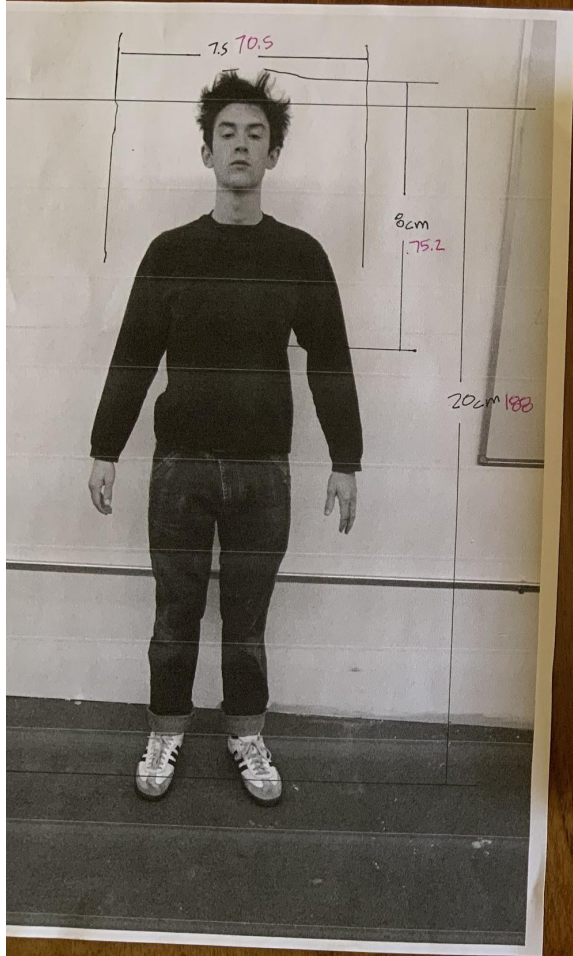

Height of this student in
real life

188 cm (or 6 feet 2 inches)

Height on paper = 20 cm

$$\frac{188}{20} = 9.4$$

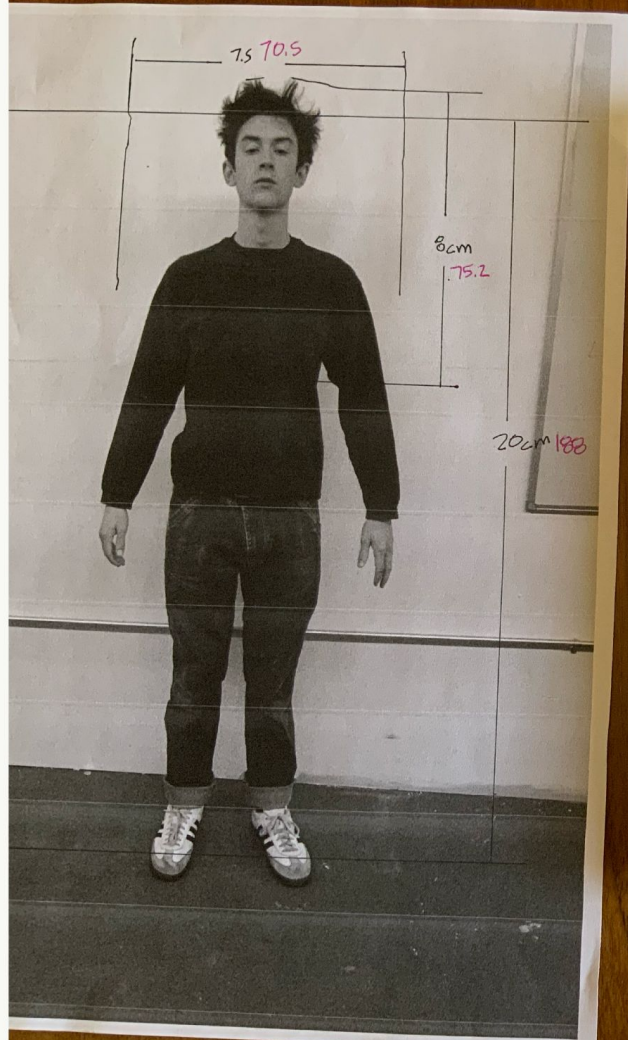

Height of this student in
real life

188 cm (or 6 feet 2 inches)

Height on paper = 20 cm

$$\frac{188}{20} = 9.4$$

9.4

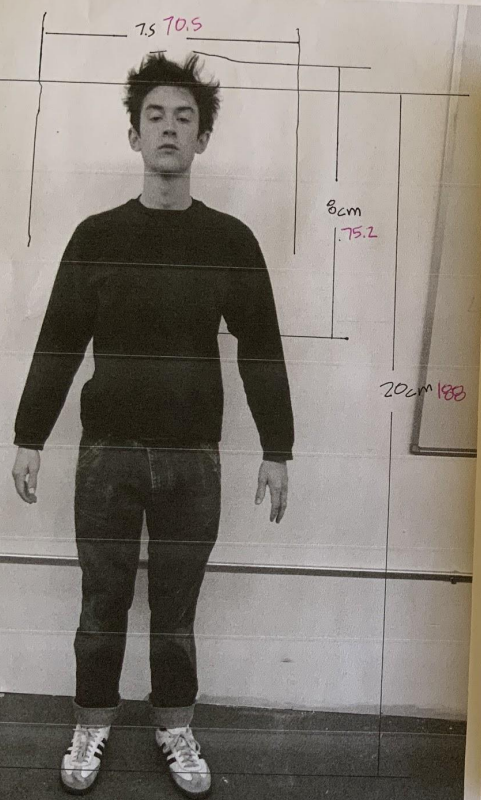

Height of this student in
real life

188 cm (or 6 feet 2 inches)

Height on paper = 20 cm

$$\frac{188}{20} = 9.4$$

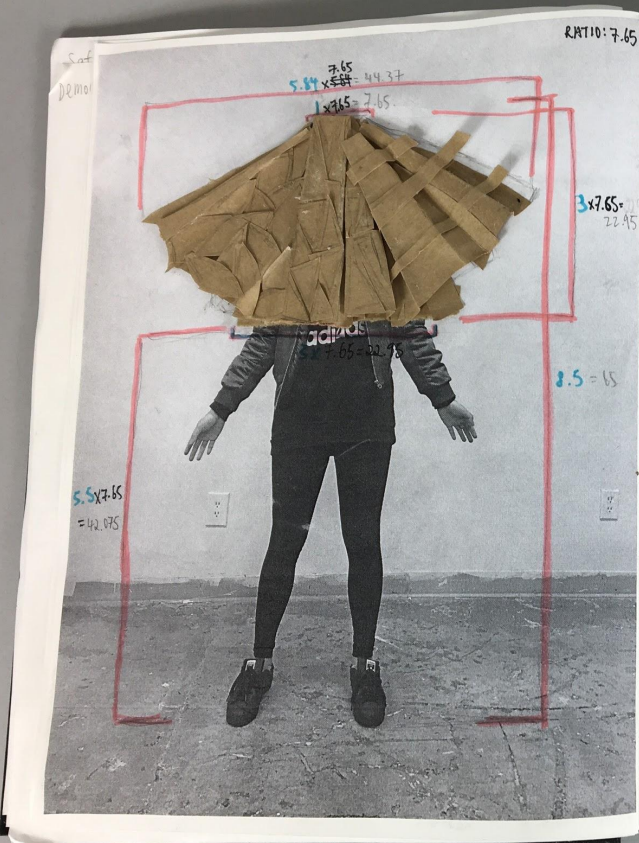

CALCULATION

RATIO: 5

MODEL	REAL LIFE
4.6 (HEIGHT)	22.95
8.2 (RADIUS)	41
4.2 (LENGTH)	21
0.8 (CUT)	4
4.8 (SIDE)	24

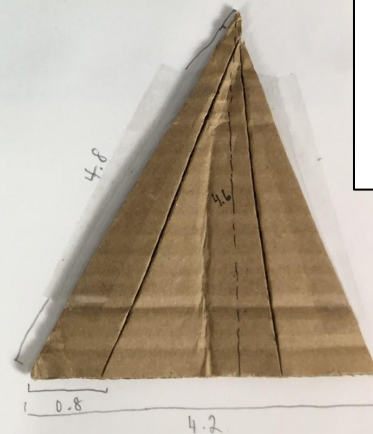

Keep your work and your notes in one place, like your sketchbook.

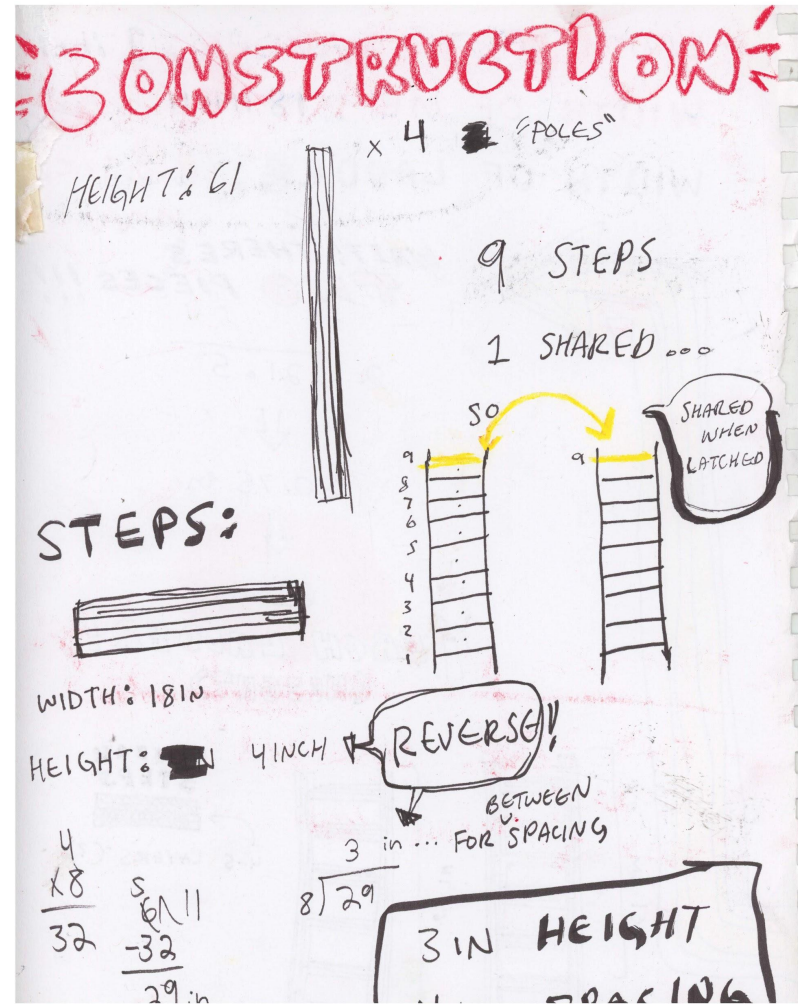
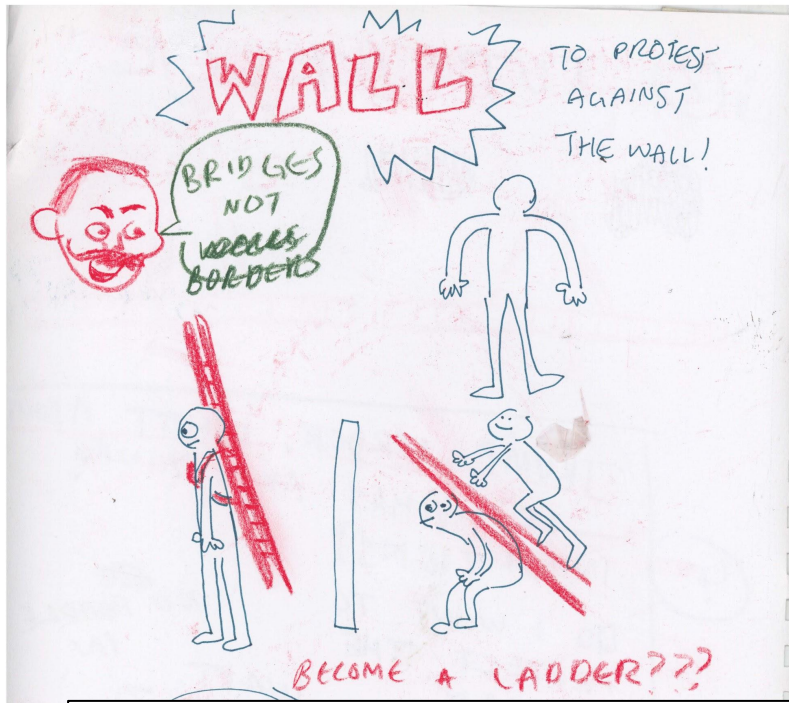

It is OK to do it in your own style. As long as all the information is there.

BECOME A LADDER

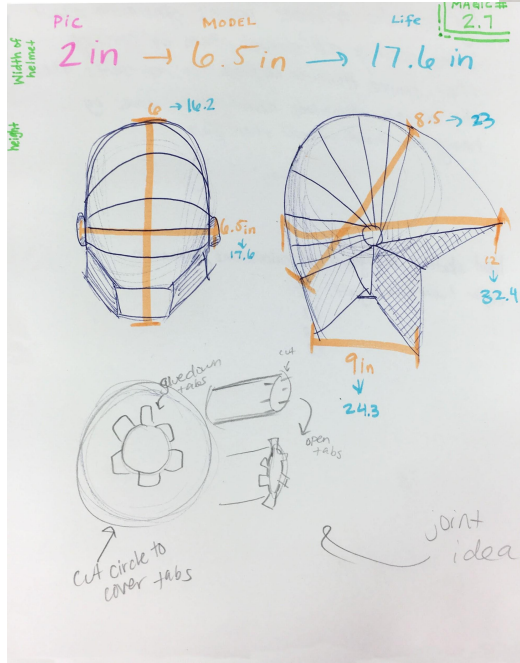

Sketch

8.8

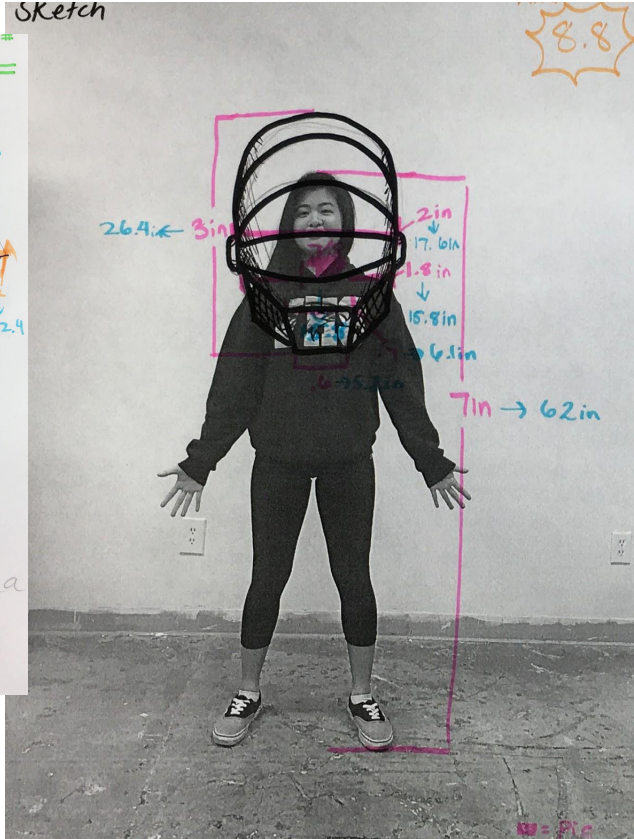

Collage

8.8

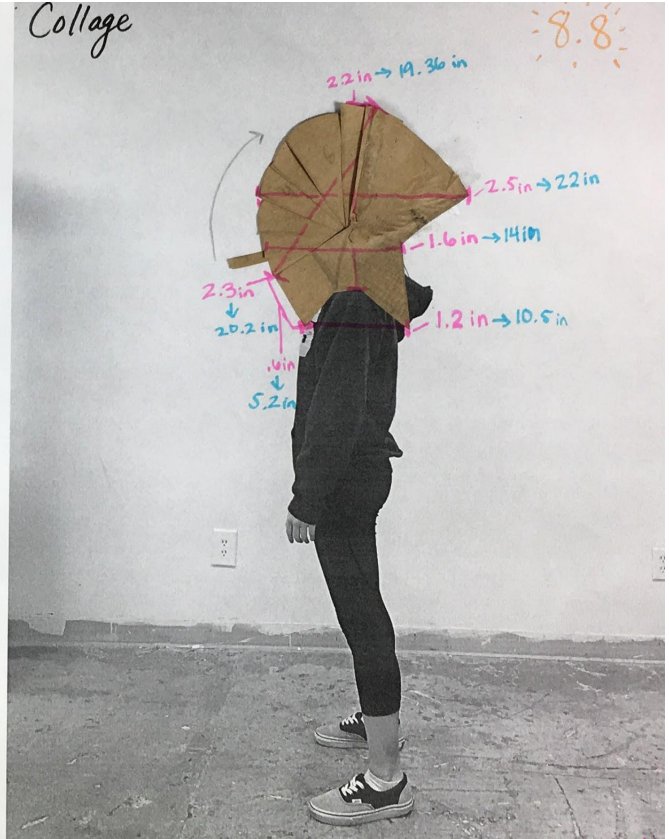

Precision is important. Don't guess.

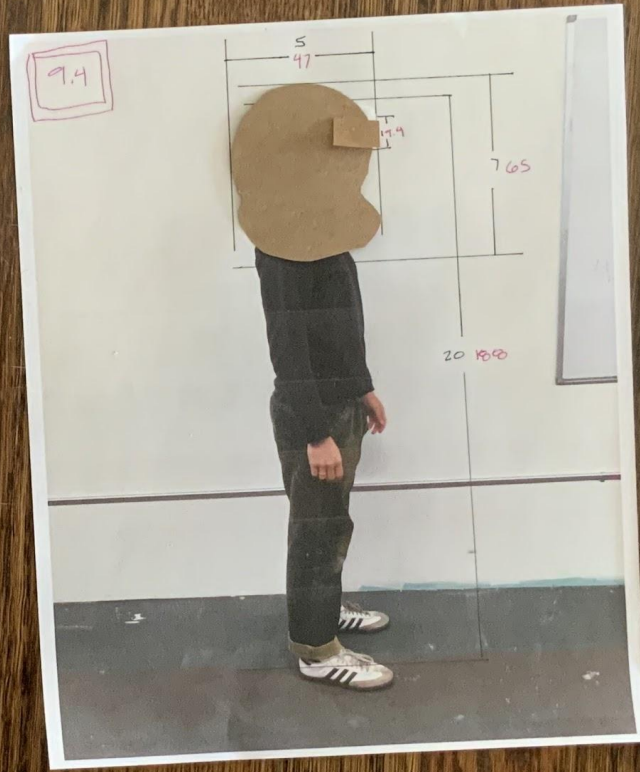
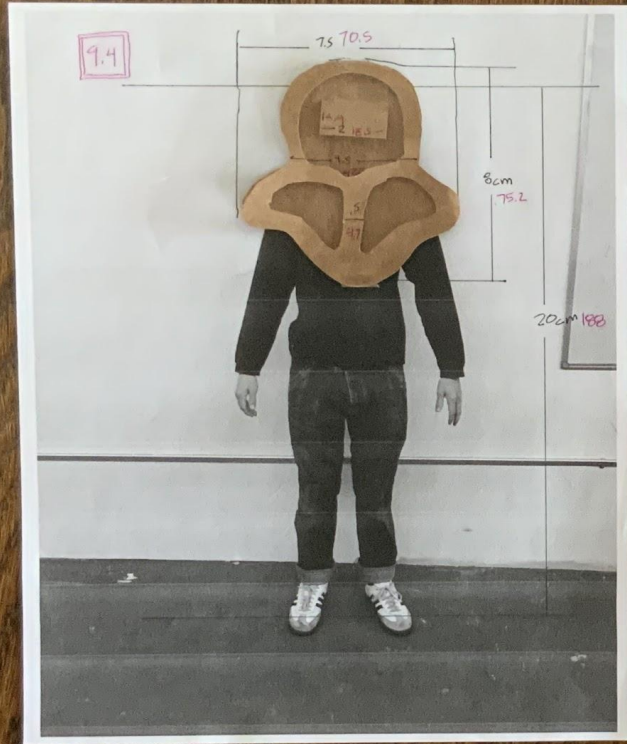

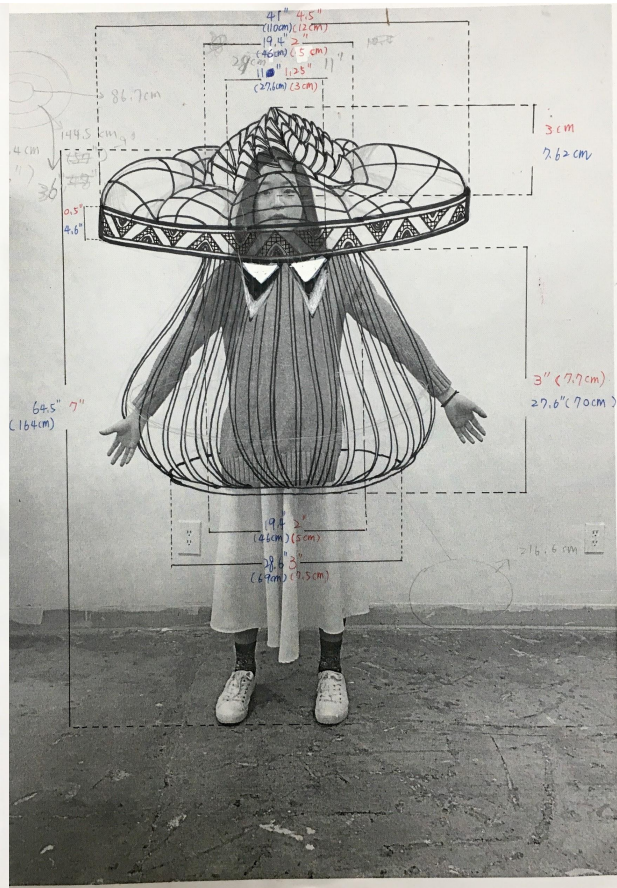

Craft and Measuring are best friends.

Protest Prosthetics

Craft- How well made is it?

Quantitative Reasoning - Can you calculate scale and use good measurements?

Social Responsibility- Does it connect to a social issue you care about?

Professional Practice- Did you do a good job of documenting your process and your final piece?